

Data Sheet



Article number: 5031030

Description: Open pillow block PMN 30
FM standard bearing included

Measures

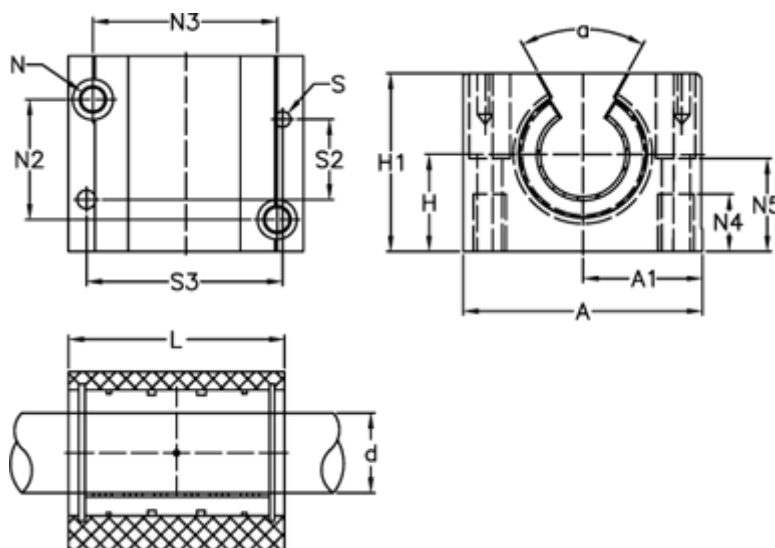

A = 87	N3 = 68.00
a = 60 degrees	N4 = 22
A1 = 44.0	N5 = 34.0
H = 35	S = 6
H1 = 60	S2 = 30
L = 79	S3 = 72
N = M10 x 1,5	Static load (kg) = 4284
N2 = 45.00	Weight (kg) = 1.000